

JA34 Installation Kit INST-JA34

Contents:

JAC P/N	DESCRIPTION	QTY
CON-3420-0025	CONNECTOR ASSEMBLY	1
CON-5500-0375	TAG RING	1
WIR-HTSK-0750	HEATSHRINK TUBING	1

Standard D-Sub Crimp Tool Chart			
TOOL TYPE	HAND CRIMPING TOOL	POSITIONER	INSERTION/EXTRACTOR TOOL
POSITRONIC	9507-0-0-0	9502-5-0-0	4711-2-0-0
DANIELS	AFM 8	K13-1	91067-2
MIL-SPEC	M22520/2-01	M22520/2-08	M81969/1-02

- Slide Heat-shrink tubing (M12) and Tag Ring (M9) over wiring harness.
- Strip outer jacket of shielded conductors approximately 3" from connector end.
- Extract conductors through shield at the 3" mark.
- Flatten and face shields pigtails away from connector end.
- Strip and crimp Pins (M11) to wires.
- Insert Pins (M11) into Connector (M10).
- Insert Spring (M4) into Body (M1).
- Place Lock-arm (M3) over Connector (M10) and secure to Body (M1) with Screws (M8).
- Place Clamp (M5) around wire harness and secure with screws (M6).
- Place Clamp (M5) partially into Body (M1) and secure with Hood (M2) and Screws (M7).
- Position Tag-Ring body (M9) on the connector side of the pigtails and Tag Ring nut after the pigtails.
- Distribute pigtails uniformly into the Tag Ring (M9) slots. If necessary, double back pig-tails to achieve uniform shield thickness between adjacent slots.
- Tighten Tag-Ring nut securely. Leave pigtails approximately 1" long to facilitate repairs.
- Flatten pigtails against the Tag Ring body.
- Slide Heat-Shrink (M12) over the Tag Ring and shrink in place.

ITEM NO.	DESCRIPTION	QTY
M1	BODY	1
M2	HOOD	1
M3	LOCKARM	1
M4	SPRING	1
M5	CLAMP	2
M6	CLAMP SCREW	2
M7	FLATHEAD SCREW	2
M8	PANHEAD SCREW	2
M9	TAG RING	1
M10	CONNECTOR	1
M11	PINS	25
M12	HEATSHRINK TUBING	2"

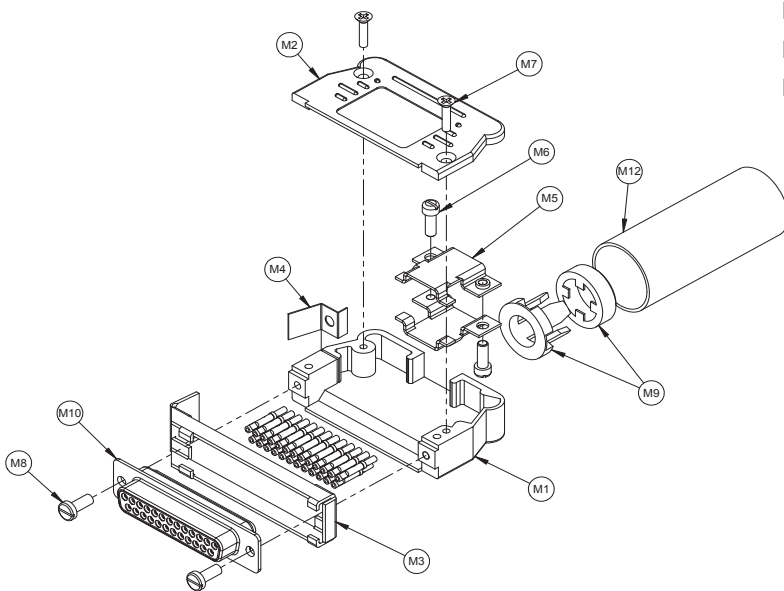

25 Pin Connector Assembly

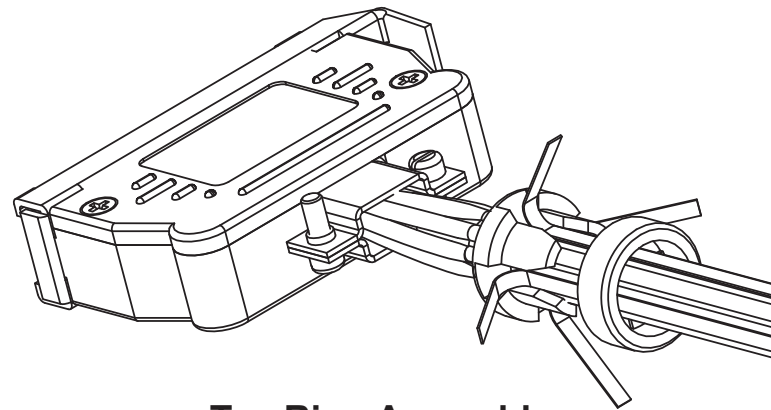

Tag Ring Assembly